

Article number: 2082266M1215B

Description: E+G Mini indexing plunger
with/without rest position, GN 822.6-6-M12x1,5-B

Measures

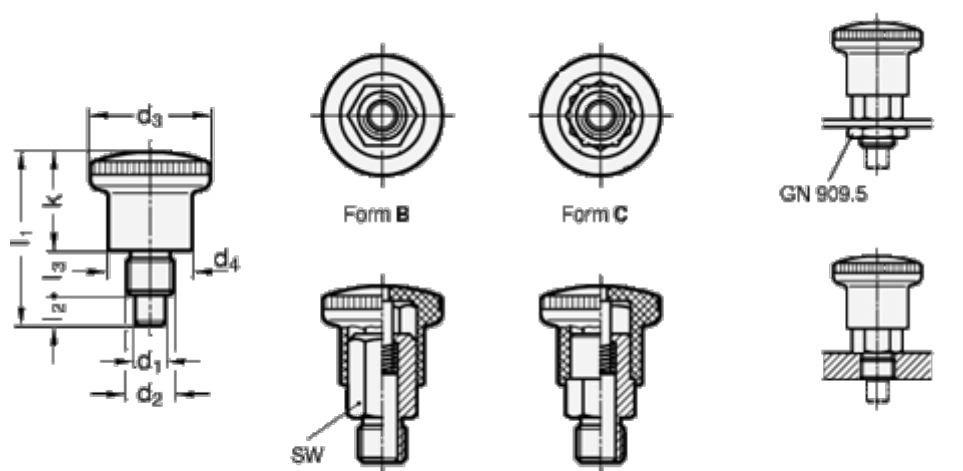

$d_1 = 6$
 $d_2 = M12x1,5$
 $d_3 = 28$
 $d_4 = 20$
 $k = 23.5$
 $l_1 = 40.5$
 $l_2 = 7$
 $l_3 = 10$

Spring load initial $N = 10$